

**Peças de Reposição | Pronta Entrega**  
**Spare parts | Prompt Delivery**  
**Repuestos | Entrega Imediata**

**Extrusora/ Extruder/ Extrusoras**



**Mecedor de Umidade e Temperatura - Secador**  
**Humidity and Temperature Meter - Dryer**  
**Sensor de Humedad y Temperatura - Secador**



**Analizador de Atividade de Água e Medidor de Densidade - Secador**  
**Water Activity Analyzer and Density Meter - Dryer**  
**Analizador de Actividad de Agua y Medidor de Densidad - Secador**



**Peletizadora/ Pellet Mill/ Peletizadora**



**Moinho/ Hammer Mill/ Molino**

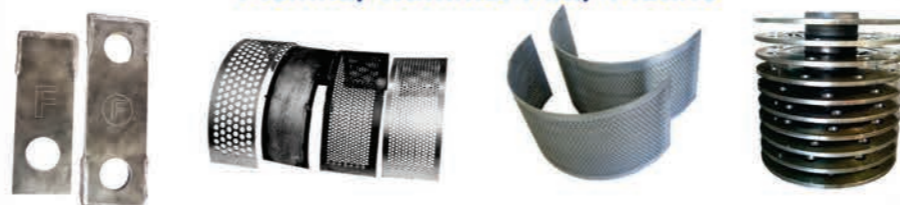

Via Anhanguera, Km 320 | 14070-730 | Ribeirão Preto | SP | Brasil  
 Tel.: 55 16 3934.1055 | Fax: 55 16 3615.7304  
 vendas@ferrazmaquinas.com.br | www.ferrazmaquinas.com.br



**Peletizadora**  
**Pellet Mill**  
**Peletizadora**



**Extrusora**  
**Extruder**  
**Extrusoras**



**Recobridor Óleos/**  
**Palatabilizantes**  
**Batch Coating**  
**System for**  
**Fats and Flavors**  
**Encobridor de**  
**Grasas/**  
**Saborizantes**



**Silos**  
**Silos**  
**Silos**



**Secadores**  
**Dryer**  
**Secador**



**Enscadeira**  
**Bagger**  
**Embolsadora**



**Resfriador**  
**Counter Flow**  
**Enfriador**



**Moinho**  
**Hammer Mill**  
**Molino**



**Peneira Vibratória**  
**Vibratory Sieve**  
**Zaranda Vibratoria**



**Misturador de Pás**  
**Paddle Mixer**  
**Mezclador Paletas**  
**Fast Mix**



**Peneira Vibratória**  
**Vibratory Sieve**  
**Zaranda Vibratoria**



**Misturador Horizontal**  
**Horizontal Mixer**  
**Mezclador Horizontal**



**Peneira Rotativa**  
**Feed Cleaner**  
**Zaranda Rotativa**

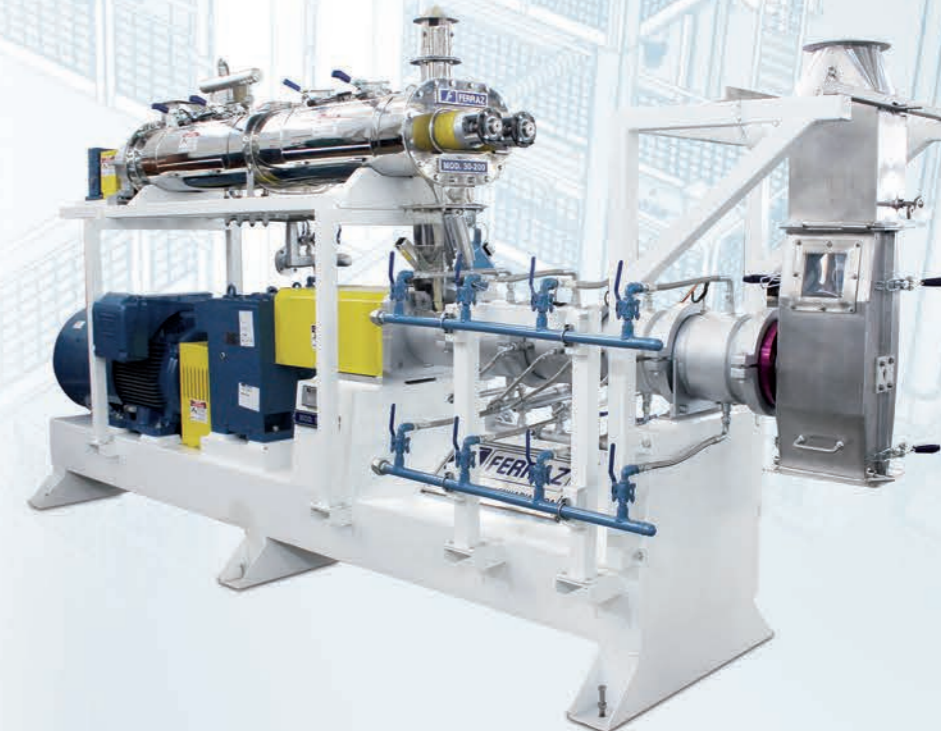

**LINHA COMPLETA DE EQUIPAMENTOS**  
**PARA PRODUÇÃO DE RAÇÃO ANIMAL**

**COMPLETE EQUIPMENT LINE**  
**FOR ANIMAL FEED PRODUCTION**

**LÍNEA COMPLETA DE EQUIPOS**  
**PARA LA PRODUCCIÓN**  
**DE ALIMENTOS PARA ANIMALES**



**Diagrama de Fluxo - Farelada e Extrusada**  
**Flowchart for Extruded Animal Feed**  
**Diagrama de Flujo - Harina y Extrusado**

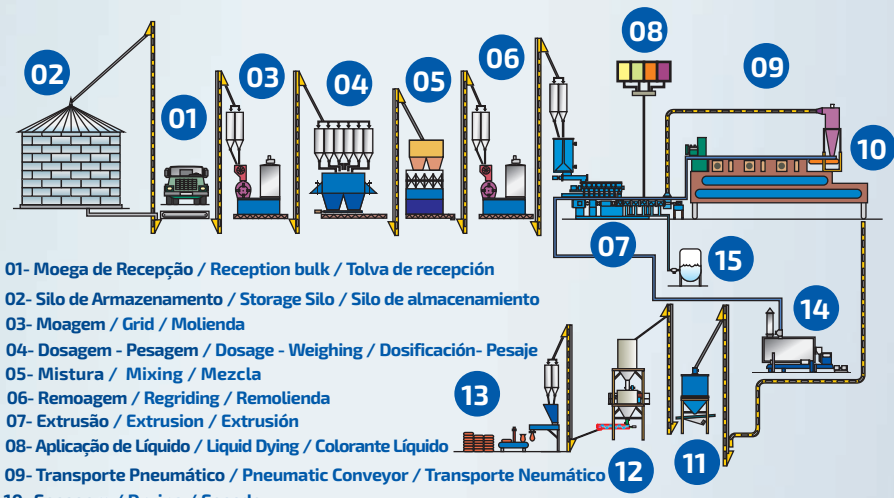

- 01- Moega de Recepção / Reception bulk / Tolva de recepción
- 02- Silo de Armazenamento / Storage Silo / Silo de almacenamiento
- 03- Moagem / Grid / Molienda
- 04- Dosagem - Pesagem / Dosage - Weighing / Dosificación- Pesaje
- 05- Mistura / Mixing / Mezcla
- 06- Remoagem / Regrinding / Remolienda
- 07- Extrusão / Extrusion / Extrusión
- 08- Aplicação de Líquido / Liquid Dying / Colorante Líquido
- 09- Transporte Pneumático / Pneumatic Conveyor / Transporte Neumático
- 10- Secagem / Drying / Secado
- 11- Resfriamento e retirada de Finos / Cooling, Take off fines / Enfriamiento e retirado de finos
- 12- Aplicação de Óleos e Palatabilizantes / Liquid Coater for fats and flavor / Aplicación de grasa y aroma
- 13- Ensaque e estocagem de produto final / Storage and Bagging finished product / Ensaque e almacenamiento producto terminado
- 14- Caldeira / Boiler (steam) / Caldera (vapor)
- 15- Tanque de água pra extrusora / Water Tank for Extruder / Tanque de agua para extrusor

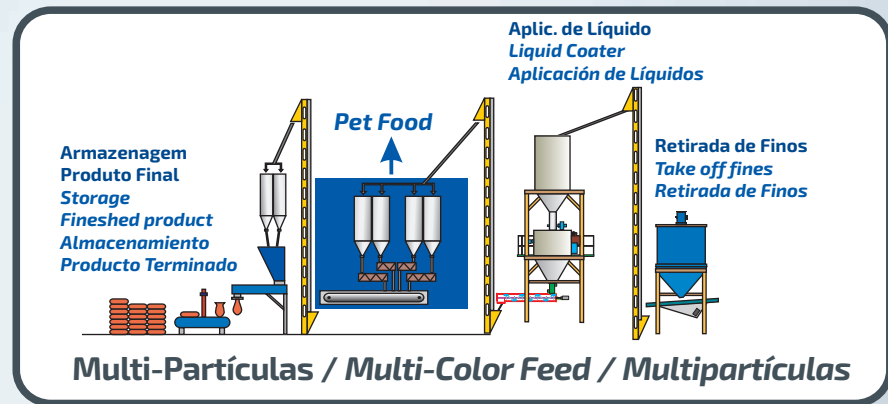

**Ração Extrusada / Extruded Feed / Alimentos Extruídos**

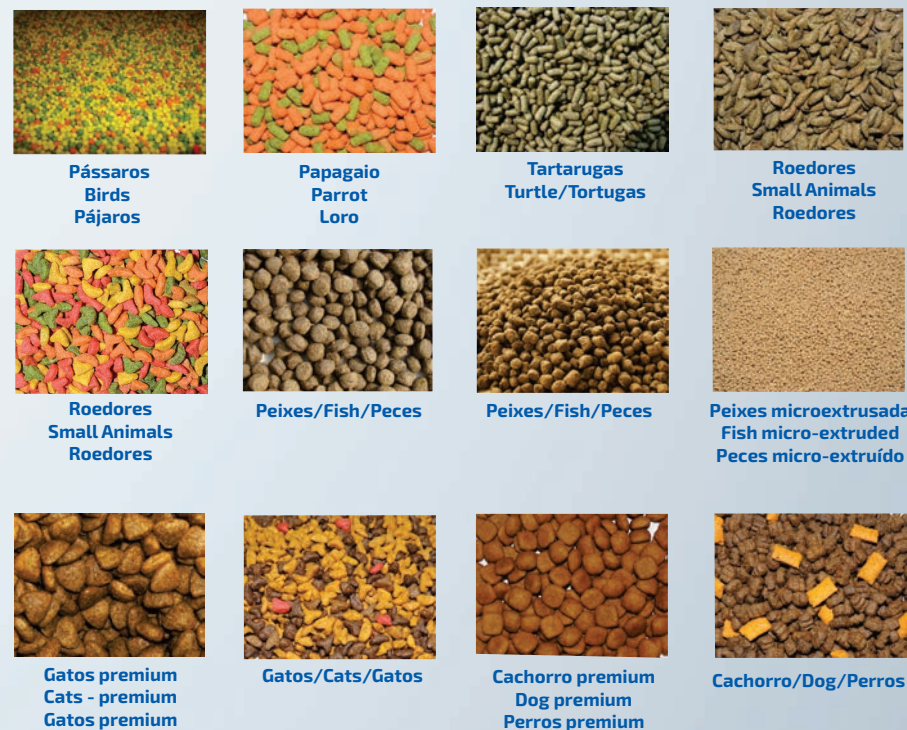

**Fábrica de Rações Extrusadas**  
**Extruded Feed Mills/ Planta de Alimento Extrusado**



**Resfriamento** / Cooling / Enfriamiento  
**Aplicação de Gordura e Palatabilizantes** / Liquid Coating for fats and flavors / Aplicación de grasa y aroma  
**Secagem** / Drying / Secado



**Dosagem Rações Coloridas** / Colored Feed / Dosaje de micro-partícula



**Extrusão** / Extrusion / Extrusión

**Fábrica de Rações Peletizadas**  
**Pelletized Feed Mills / Planta de Alimento Peletizado**



**Caçamba de Pesagem** / Weighing Bucket / Tolva Pesaje



**Carregamento a Granel** / Bulk Load / Carga a Granel



**Pelletizadora** / Pellet Mill / Pelletizadora

**Diagrama de Fluxo - Farelada e Peletizada**  
**Flowchart for Pellet Animal Feed**  
**Diagrama de Flujo - Harina y Peletizado**

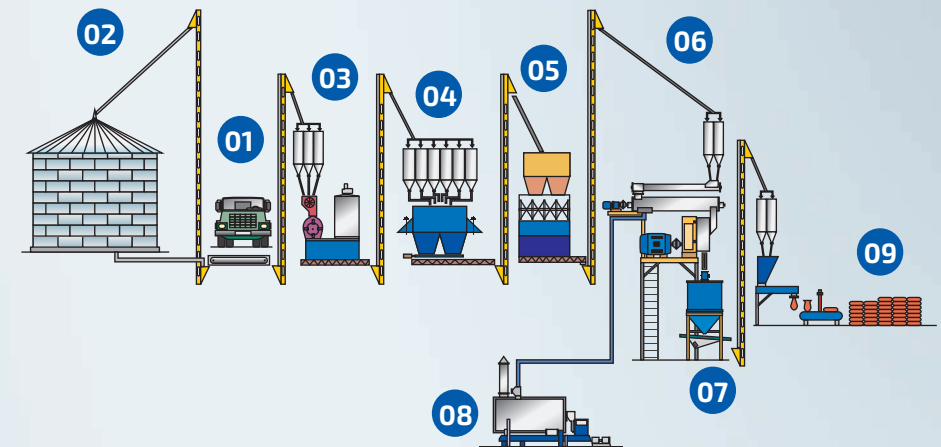

- 01- Moega de Recepção de matéria-prima / Reception bulk / Tolva de recepción de materia prima
- 02- Silo Armazenamento matéria-prima / Silo Storage / Silo de Almacenamiento de materia prima
- 03- Moagem / Grid / Molienda
- 04- Dosagem e Pesagem / Dosage - Weighing / Dosificación - Pesaje
- 05- Mistura / Mixing / Mezcla
- 06- Peletização / Pelletized / Peletizado
- 07- Resfriamento - retirada de finos / Cooling - take off fines / Enfriamiento y retirada de finos
- 08- Caldeira (vapor) / Boiler ( Steam ) / Caldera (Vapor)
- 09- Ensaque e armazenagem produto final / Storage and finished product / Embolsado y almacenamiento

**Ração Peletizada / Pelletized Feed / Alimentos Peletizados**

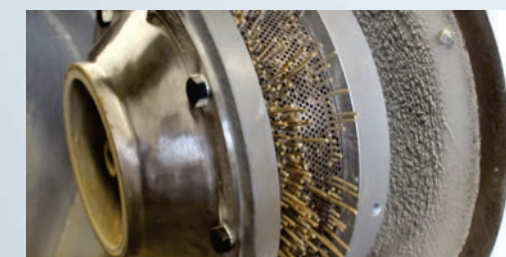

**Produto saindo da matriz** / Product coming out of the matrix / Producto dejando la Matriz